

# Technical data

## UPS 50-60 F/SF

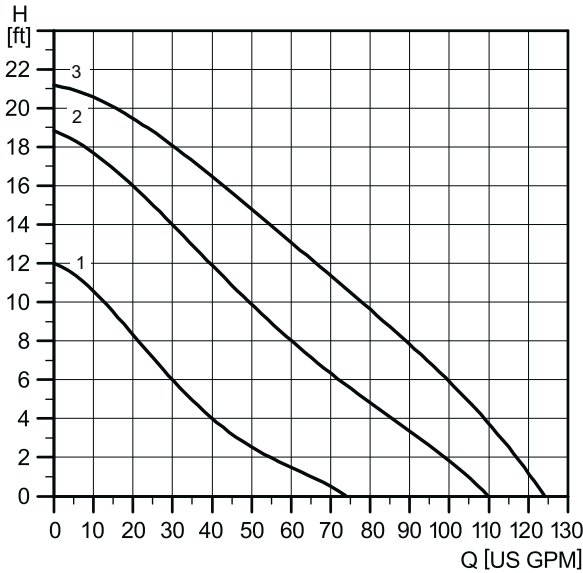

TM04 7918 2410

Flow range: 120 gpm  
 Head range: 21 feet  
 Motors: 2-pole, single-phase  
 Max. liquid temperature: 230 °F (110 °C)  
 Min. liquid temperature: 36 °F (10 °C)  
 Max. system pressure: 145 psi (10 bar)  
 Closed or Open system

| Model          | Spd | Volts | Amps | Watts | Hp  | Capacitor |
|----------------|-----|-------|------|-------|-----|-----------|
| UPS 50-60 F/SF | 3   | 115   | 3.6  | 395   | 1/6 | 40µF/180V |
|                | 2   |       | 3.4  | 350   | 1/6 |           |
|                | 1   |       | 2.7  | 260   | 1/6 |           |
|                | 3   | 208   | 1.9  | 395   | 1/6 | 10µF/400V |
|                | 2   |       | 1.7  | 350   | 1/6 |           |
|                | 1   |       | 1.4  | 290   | 1/6 |           |
| 3              | 230 | 1.8   | 395  | 1/6   |     |           |
| 2              |     | 1.7   | 350  | 1/6   |     |           |
| 1              |     | 1.4   | 260  | 1/6   |     |           |

UPS 50-60 F/SF

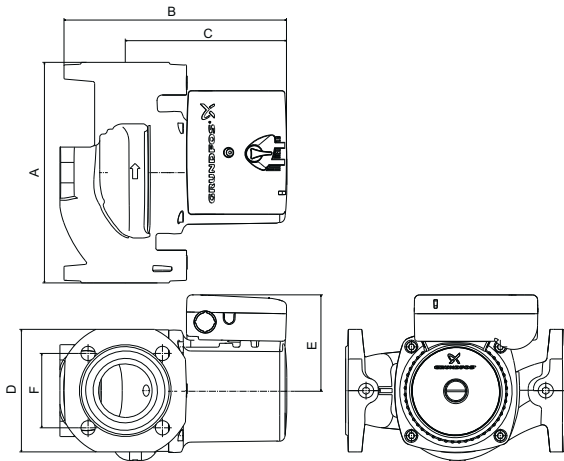

TM04 9775 0111

### Approvals



| Model type   | Product number |             | Dimensions [inches] |       |       |       |       |       | Connection type and size | Shipping weight [lbs] |
|--------------|----------------|-------------|---------------------|-------|-------|-------|-------|-------|--------------------------|-----------------------|
|              | 115 V          | 208 - 230 V | A                   | B     | C     | D     | E     | F     |                          |                       |
| UPS 50-60 F  | 97523134       | —           |                     |       |       |       |       |       |                          | 20                    |
| UPS 50-60 F  | —              | 97523135    |                     |       |       |       |       |       |                          | 20                    |
| UPS 50-60 SF | 97523136       | —           | 8 1/2               | 8 5/8 | 6 1/4 | 4 3/4 | 3 3/4 | 2 7/8 | GF 50                    | 19.5                  |
| UPS 50-60 SF | —              | 97523137    |                     |       |       |       |       |       |                          | 19.5                  |

Note: Dimensions in inches unless otherwise noted.



# Submittal Data Information

101-035

## Model 0012 Cartridge Circulator

Effective: November 20, 2008

Supersedes: October 1, 2002

Job: \_\_\_\_\_ Engineer: \_\_\_\_\_ Contractor: \_\_\_\_\_ Rep: \_\_\_\_\_

| ITEM NO. | MODEL NO. | IMP. DIA. | G.P.M. | HEAD/FT. | H.P. | ELEC. CHAR. |
|----------|-----------|-----------|--------|----------|------|-------------|
|          |           |           |        |          |      |             |

### Features

- Exclusive ACB Anti-Condensate Baffle with Ambient Air Flow-Protects Motor Windings against Condensate Buildup
- High Velocity Performance-Compact Design
- Quiet, Efficient Operation
- Direct Drive-Low Power Consumption
- Unique Replaceable Cartridge Design-Field Serviceable
- Self Lubricating
- No Mechanical Seal
- Unmatched Reliability-Maintenance Free
- Universal Flange to Flange dimensions
- Cast Iron, Bronze or Stainless Steel Construction

### Materials of Construction

Casing (Volute): Cast Iron, Bronze or Stainless Steel  
 Stator Housing: Aluminum  
 Cartridge: Stainless Steel  
 Impeller: Non-Metallic  
 Shaft: Ceramic  
 Bearings: Carbon  
 O-Ring & Gaskets: EPDM

### Model Nomenclature

F – Cast Iron, Flanged  
 BF – Bronze, Flanged  
 SF – 304 Stainless Steel, Flanged

### Variations:

Z – Zoning Circulator  
 J – Bronze Cartridge with Cast Iron Casing

### Performance Data

Flow Range: 0 – 50 GPM  
 Head Range: 0 – 14.5 Feet  
 Minimum Fluid Temperature: 40°F (4°C)  
 Maximum Fluid Temperature: 230°F (110°C)  
 Maximum Working Pressure: 125 psi  
 Connection Sizes: 1-1/4", 1-1/2" or 2" Flanged

### Application

The Taco 0012 is specifically designed for high flow / medium head applications in large residential and light commercial systems. Ideal for large BTUH Boilers, 2" recirculation systems, Primary/Secondary loops, commercial water heaters and light commercial heating and cooling systems. The Bronze or Stainless Steel 0012 can be used on open loop systems. The unique replaceable cartridge contains all of the moving parts and allows for easy service instead of replacing the entire circulator. Universal flange to flange dimensions and orientation allows the 0012 to easily replace other models. Compact, low power consumption design makes it ideal for high-efficiency jobs. The 0012-F4 is a direct replacement for the HV Series and the 0012-F4-I is a direct replacement for the 2" Series using existing flanges.

### Pump Dimensions & Weights

| Model      | Flange | Casing    | A     |     | B     |     | C     |     | D      |    | F   |    | G     |     | Ship Wt. |     |
|------------|--------|-----------|-------|-----|-------|-----|-------|-----|--------|----|-----|----|-------|-----|----------|-----|
|            |        |           | in.   | mm  | in.   | mm  | in.   | mm  | in.    | mm | in. | mm | in.   | mm  | lbs.     | Kg  |
| 0012-F4    | 1-1/2" | Cast Iron | 8-5/8 | 219 | 6-3/8 | 162 | 4-1/4 | 108 | 3-5/16 | 84 | 6   | 52 | 8-1/2 | 216 | 13.0     | 5.9 |
| 0012-F4-I  | 2      | Cast Iron | 9     | 229 | 6-3/8 | 162 | 4-1/4 | 108 | 3-5/16 | 84 | 6   | 52 | 8-1/2 | 216 | 13.0     | 5.9 |
| 0012-BF4   | 1-1/2" | Bronze    | 8-5/8 | 219 | 6-3/8 | 162 | 4-1/4 | 108 | 3-5/16 | 84 | 6   | 52 | 8-1/2 | 216 | 13.0     | 5.9 |
| 0012-BF4-I | 2      | Bronze    | 9     | 229 | 6-3/8 | 162 | 4-1/4 | 108 | 3-5/16 | 84 | 6   | 52 | 8-1/2 | 216 | 13.0     | 5.9 |
| 0012-SF4   | 1-1/2" | St. Steel | 8-5/8 | 219 | 6-3/8 | 162 | 4-1/4 | 108 | 3-5/16 | 84 | 6   | 52 | 8-1/2 | 216 | 13.0     | 5.9 |

\* Flanges included.

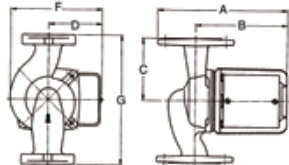

### Mounting Positions

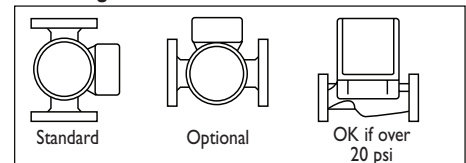

### Electrical Data

| Model         | Volts   | Hz | Ph | Amps | RPM  | HP  |
|---------------|---|----|----|------|------|-----|
| All Models    | 115   | 60 | 1  | 1.33 | 3250 | 1/8 |
| Motor Type    | Permanent Split Capacitor Impedance Protected |    |    |      |      |     |
| Motor Options | 220/50/1, 220/60/1, 230/60/1, 100/110/50/60/1 |    |    |      |      |     |

### Flange Orientation

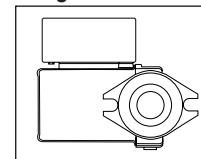

### Performance Field – 60Hz

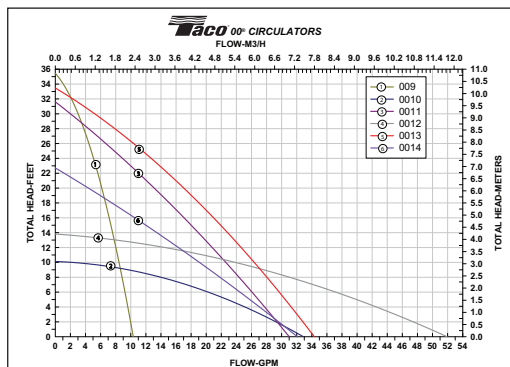

FOR INDOOR USE ONLY

**Do it Once. Do it Right.®**

TACO INC., 1160 Cranston Street, Cranston, RI 02920 Telephone: (401) 942-8000 Fax: 942-2360  
 TACO (Canada), Ltd., 6180 Ordan Drive, Mississauga, Ontario L5T 2B3 Telephone: (905) 564-9422 Fax: (905) 564-9436  
 Visit our website at: www.taco-hvac.com

Printed in USA  
 Copyright 2008  
 TACO, Inc.



# Submittal Data Information

## Variable Speed "00" Circulators

101-091

Effective: November 1, 2003

Supersedes: NEW

Job: \_\_\_\_\_ Engineer: \_\_\_\_\_ Contractor: \_\_\_\_\_ Rep: \_\_\_\_\_

| ITEM NO. | MODEL NO. |  |
|----------|-----------|--|
|          |           |  |

### General Variable Speed "00" Circulator Features

- Available in all Styles of 003-0014
- All-in-One Pump / Control
- Sensors Included
- Easy to Wire
- UL Approved
- Snap-in PC Board
- Fuse Protected
- Plug-in Low Voltage Wiring Terminal
- Optional Integral Flow Check
  - Prevents Gravity Circulation
  - Specially Designed for Variable Speed Systems
  - Easy to Service
  - Patented

### Additional 00-VR (Outdoor Reset) Features

- Adjustable Heating Curve (0.2 to 2.2)
- Selectable Maximum Supply Temperature (110°F, 130°F, 150°F, or Off)
- Selectable Minimum Boiler Return Temperature (120°F, 135°F or Off)
- Minimum Supply Temperature (85°F or Off – Default to Heating Curve)
- System and/or Boiler Pump Contact (Line Voltage, 5 amp max.)
- LED Status Panel
- Pump Exercise (10 Seconds After 3 Days of No Operation)
- Post Purge (20 Seconds)
- Fail Safe Mode (Assumes Outdoor Temp of 32°F)
- 2 Second Start Delay Prevents Short Cycling

### Additional 00-VS (Set Point) Features

- Adjustable Setpoint (30° - 210°F)
- Adjustable Temperature Difference ( $\Delta T$ ) (5° - 50°F)
- Boiler Protection (135°F)
- Boiler Protection as a Limit Control (75° - 165°F)
- LED Status Panel
- Direct or Reverse Acting
- Selectable Output Response Speed
- Linear or Logarithmic Output
- Pump Exercise (10 Seconds After 3 Days of No Operation)

### Additional 00-VV (Variable Voltage) Features

- 4 Signal Voltage Ranges (0-10 V(dc), 0-20 mA, 2-10 V(dc), or 4-20 mA)
- Internal LED's
- Manual Operation Switch
- Linear or Logarithmic Output
- Pump Exercise (10 Seconds After 3 Days of No Operation)

### Variable Speed Outdoor Reset "00" Circulator (00-VR) Application

Outdoor reset controls the hot water supply temperature, so that the heat supplied to the building equals the heat loss by the building. The 00-VR modulates the circulator to inject hot water from the boiler loop into the radiant or reduced temperature loop while providing Outdoor Reset to a heating system (see figure A). Available in any style 003 – 0014, the 00-VR also comes with a boiler sensor to protect against low return temperatures. The 00-VR is the ultimate for protection, control, ease of installation, and trouble free operation.

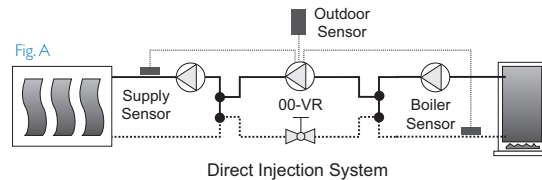

See applications brochure for additional schematics.

### Variable Speed Setpoint "00" Circulator (00-VS) Application

The versatile Setpoint version of the Variable Speed "00" can be set up to deliver a fixed temperature, maintain a specific temperature drop between sensor locations ( $\Delta T$ ), used as a bypass / shunt pump or integrated into a fan coil package to vary the speed of the pump based on supply air temperature.

The 00-VS can be either direct acting (speed increases on a temperature decrease) or reverse acting (speed increases on a temperature increase). A typical direct acting (limiting setpoint) application would be for boiler protection, where the 00-VS is installed on a bypass loop (see figure B). If the return temperature starts to drop below the set temperature (75° - 165°F) then the speed of the pump will be increased, bypassing hot water to protect the boiler.

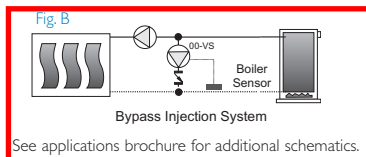

See applications brochure for additional schematics.

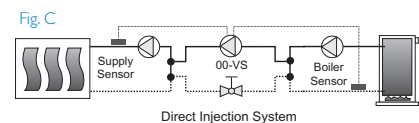

The 00-VS can be used in radiant injection mixing systems where you want to set a fixed supply water temperature (see figure C). Through the use of the setpoint dial on the PC board any temperature from 30°-210°F can be selected. If desired, a boiler protection sensor can be installed to protect the boiler from flue gas condensation.

In the  $\Delta T$  mode the pump speed is varied to maintain a set temperature drop (5°-50°F) across a boiler or heat exchanger, ideal for snowmelt applications.

### Variable Speed Variable Voltage "00" Circulator (00-VV) Application

The Variable Voltage version of the Variable Speed "00" Circulator is designed to operate the pump at different speeds based on an externally generated analog voltage signal input. Its reliable operation, ease of installation and integration to DDC or building management systems allows for a wide variety of HVAC applications, such as maintaining a pressure differential or a setpoint temperature. The control accepts a 0-10 V(dc), 0-20 mA, 2-10 V(dc), or 4-20mA signal.

## Do it Once. Do it Right.

Taco, Inc., 1160 Cranston Street, Cranston, RI 02920 Telephone: (401) 942-8000 Fax: (401) 942-2360  
 Taco (Canada), Ltd., 6180 Ordan Drive, Mississauga, Ontario L5T 2B3 Telephone: (905) 564-9422 Fax: (905) 564-9436

Visit our website at: [www.taco-hvac.com](http://www.taco-hvac.com)

Printed in USA  
Copyright 2005  
TACO, Inc.



# Instruction Sheet

## Variable Speed - Setpoint (00-VS) "00" and Load Match® Cartridge Circulators

102-143

SUPERSEDES: May 1, 2010

EFFECTIVE: October 1, 2010

Plant ID# 001-3811

The Variable Speed - Setpoint "00" Cartridge Circulator (00-VS) is a microprocessor-based pump designed to regulate the temperature to a system through variable speed injection mixing. The 00-VS regulates the temperature to provide a fixed setpoint or a fixed temperature difference ( $\Delta T$ ) for heating or cooling applications. For fixed setpoint operation, a boiler return sensor can be connected to protect the boiler against flue gas condensation.

In order to properly accomplish this mixing method, the following piping details should be considered.

### Applications

The following are typical applications the 00-VS supports. The 00-VS includes a five DIP package with DIP switches 1, 3 and 5 used to configure the control for a given application. These DIP switch configurations are indicated to the right of the application drawing. DIP switch 2 is used to select the appropriate temperature range for the desired setpoint target. DIP switch 4 is used to select the controls variable speed output response. It is recommended that a normal response (DIP 4 = Off) is used. This will aid in reducing potential thermal expansion issues in a system. If it is desired for the control to achieve the setpoint or  $\Delta T$  target quicker, a more aggressive variable speed output response can be selected by setting DIP switch 4 to On.

#### 00-VS-1

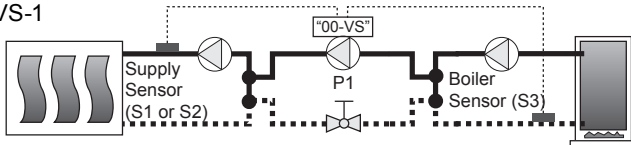

DIP 5 = Off (Linear Output Characteristic)  
DIP 3 = Off (Direct Acting)  
DIP 1 = Off (Setpoint Target)

On Off

The 00-VS adjusts the variable speed output to the P1 pump to maintain a setpoint temperature at the supply sensor whenever a heat demand is present. While the control is operating to maintain the setpoint temperature, the variable speed output is also adjusted to ensure the boiler inlet temperature is above the boiler inlet minimum setpoint.

#### 00-VS-2

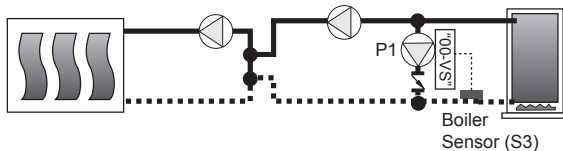

DIP 5 = Off (Linear Output Characteristic)  
DIP 3 = On (Reverse Acting)  
DIP 1 = Off (Setpoint Target)

On Off

The 00-VS adjusts the variable speed output to the P1 pump to maintain at least a setpoint temperature at the boiler sensor (S3) whenever a heat demand is present. The control adjusts the variable speed output towards zero speed as long as the temperature is above the setpoint.

#### 00-VS-3

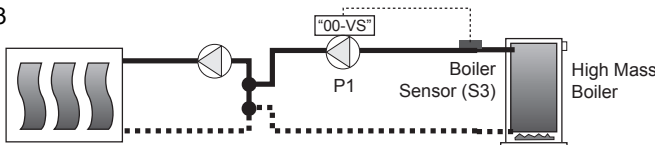

DIP 5 = Off (Linear Output Characteristic)  
DIP 3 = Off (Direct Acting)  
DIP 1 = Off (Setpoint Target)

On Off

The 00-VS adjusts the variable speed output to the P1 pump to maintain at least a setpoint temperature at the boiler sensor (S3) whenever a heat demand is present. The control adjusts the variable speed output towards full speed as long as the temperature is above the setpoint. Note: This application illustrates variable flow conditions through the boiler. This control configuration should only be used with a heat source which is not flow sensitive, such as a high mass cast iron boiler.

#### 00-VS-4

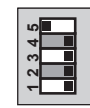
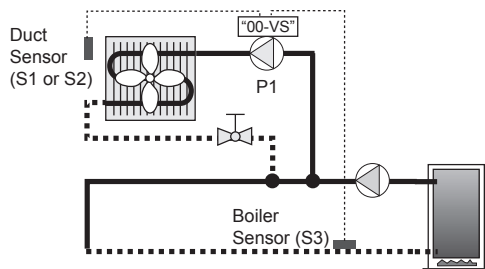

DIP 5 = On (Equal Percentage Output Characteristic)  
DIP 3 = Off (Direct Acting)  
DIP 1 = Off (Setpoint Target)

On Off

The 00-VS adjusts the variable speed output to the fancoil pump P1 to maintain a setpoint discharge air temperature at the duct sensor whenever a heat demand is present. While the control is operating to maintain the setpoint temperature, the variable speed output is adjusted to ensure the boiler inlet temperature is above the boiler inlet minimum setpoint.



A Taco resource – saving product

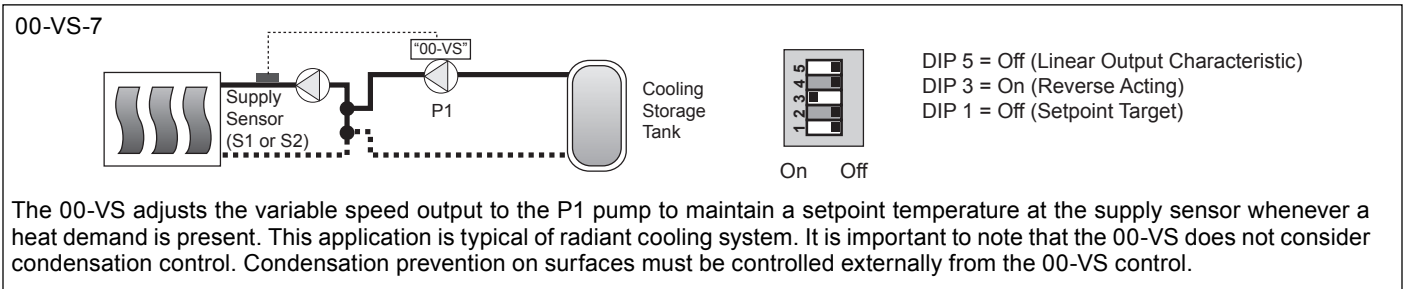
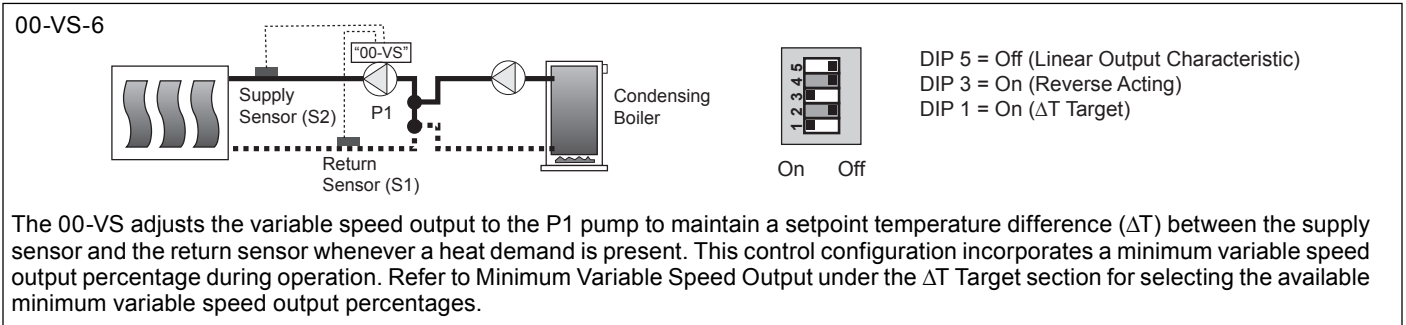
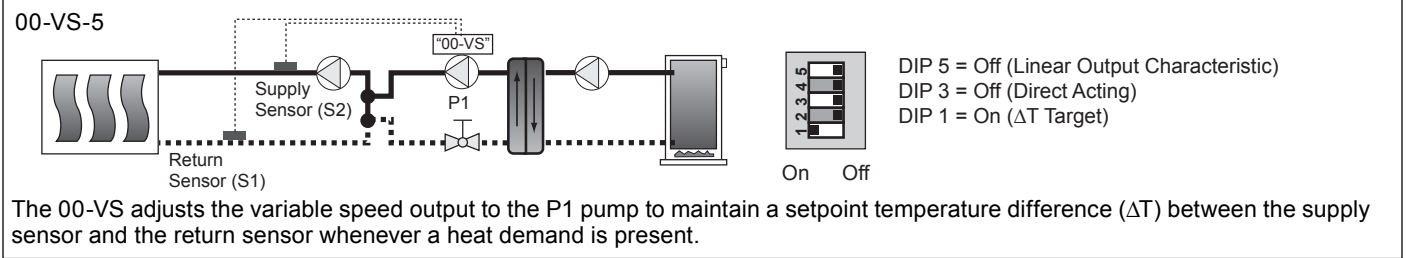

## Variable Speed Injection Mixing

Variable Speed Injection Mixing uses a pump as a mixing device instead of a 2-way, 3-way or 4-way valve. The 00-VS injects hot water from the boiler loop into the cooler system loop. The speed of the pump is modulated in order to inject different rates of hot water into the cooler system return water. This allows for virtually any water temperature to be supplied to the heating system. Most boilers cannot operate at low temperatures, therefore the 00-VS injection pump can be modulated back in order to prevent the boiler from operating at cold temperatures.

When the injection pump is turned off, there must be no heat transfer from the boiler loop to the system loop. In order to avoid this unwanted heat transfer, primary/secondary piping techniques are used as shown in figure 1.

This piping arrangement requires that the injection piping be at least one pipe diameter smaller than the piping of the boiler and system loops. There must be no more than 4 pipe diameters between the tees in the boiler and system loops (Note 1), in order to prevent ghost flow when the injection pump is off and the system or boiler pump is on. Also, there must be at least 6 pipe diameters of straight pipe on either side of the tees (Note 2), in order to prevent the momentum of water from the boiler and system loops from pushing flow through the injection loop. Finally, there should be a minimum of 1 foot drop in the injection loop in order to create a thermal trap (Note 3) in order to prevent convective heat transfer through the injection loop.

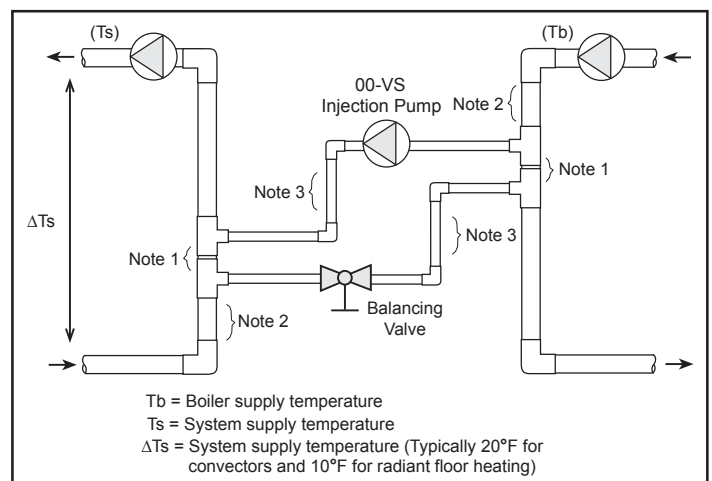

Fig. 1

## Design Procedure

In order to properly size the pump, follow the design procedure below:

- 1) Determine the design operating temperatures of the system loop and boiler. ( $T_s$  and  $T_b$  from figure 1.)
- 2) Determine the flow rate and design temperature drop ( $\Delta T$ : Delta T) in the system loop. If one of these variables is unknown, use Equation 1 or 2 to determine the other variable.
- 3) Compute  $T_b - T_s$ . Look up the flow rates on figure 2.
- 4) The design injection flow rate for direct injection is calculated in Equation 3. If the injection flow rate is greater than 40 US GPM, a 3-way or 4-way valve may be required.

- 5) Decide whether or not to include a balancing valve in the injection piping. A balancing valve allows adjustment when the injection pump is larger than needed. A balancing valve also provides the possibility of manual operation of the system by turning the injection pump fully on and adjusting the balancing valve to obtain the desired supply water temperature.
- 6) The injection pump size and model of Taco 00 pump to install can be looked up in figure 3. Do not oversize the injection system. If the injection system is not able to provide enough heat, the boiler's aquastat may be increased.

Eq. 1: System Flow Rate (US GPM) =  $\frac{\text{Design Heating Load (BTU/hr)}}{500 \times \Delta T_s (\text{°F})}$       Eq. 2:  $\Delta T_s (\text{°F}) = \frac{\text{Design Heating Load (BTU/hr)}}{500 \times \text{System Flow Rate (US GPM)}}$

Eq. 3: Design Injection Flow Rate (US GPM) = System Flow Rate (US GPM) x Flow Ratio

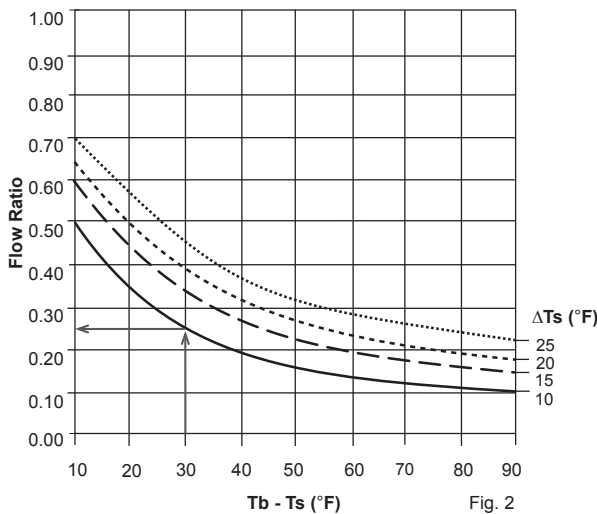

| Design Injection Flow Rate (US GPM) | Balancing Valve Position (% open) | Balancing Valve Cv | Nominal Pipe Diameter (inches) | TACO Pump |
|-------------------------------------|-----------------------------------|--------------------|--------------------------------|-----------|
| 1.5                                 | 30                                | 2.4                | 0.5                            | 003       |
| 2                                   | 40                                | 4.5                | 0.5                            | 003       |
| 3                                   | 40                                | 4.5                | 0.5                            | 006       |
| 4                                   | 100                               | 15                 | 0.5                            | 006       |
| 7                                   | 40                                | 6.9                | 0.75                           | 007       |
| 8                                   | 50                                | 10.4               | 0.75                           | 007       |
| 9                                   | 30                                | 5.76               | 1                              | 007       |
| 12                                  | 40                                | 10.8               | 1                              | 007       |
| 14                                  | 40                                | 10.8               | 1                              | 0010      |
| 16                                  | 100                               | 36                 | 1                              | 0010      |
| 20                                  | 50                                | 19.8               | 1.25                           | 0010      |
| 25                                  | 50                                | 28.8               | 1.5                            | 0010      |
| 30                                  | 30                                | 18.2               | 2                              | 0012      |
| 40                                  | 40                                | 34.2               | 2                              | 0012      |

This table assumes there are 5 feet of pipe, 4 elbows, and 4 branch tees of the listed diameter. Balancing valve is assumed to be a ball valve. The approximate Cv value is provided in order to allow for proper balancing device. Valve characteristics may vary for the same size and type of ball valve from manufacturer to manufacturer.

Fig. 3

## Sequence of Operation

### Power up and Heat Request

Whenever the 00-VS is powered up, the green PWR LED turns on. The 00-VS starts operating once a heat request signal is present at the Heat Request (Ht Req) terminals. A heat request signal may be provided by external end switches from zone valves or ZVC/SR series zone controls, applying a dry contact closure or a powered 24 V (ac) signal across the Ht Req terminals. If end switches or switching relays are not available, a jumper must be installed to provide a heat request. Once a heat request signal is present, the green HEAT REQ LED turns on.

### Mixing Operation

Once a heat request is present, the 00-VS operates to maintain a target temperature based on either a fixed setpoint or a fixed temperature difference (ΔT). The percent output (% OUT) LED flashes at different rates based on the speed of the pump. The target temperature is set using the RANGE dial, where the numbers on the dial correspond to the temperature ranges available in the applicable mode. Refer to the Setpoint and ΔT sections for a listing of the temperature ranges available.

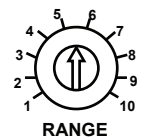

The operation of the 00-VS is based on either direct acting or reverse acting operation.

#### Direct Acting (DIP switch 3 = Off)

In direct acting operation, the 00-VS increases speed on a temperature decrease and decreases speed on a temperature increase. Direct acting operation is typically used in heating applications.

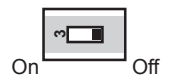

#### Reverse Acting (DIP switch 3 = On)

In reverse acting operation, the 00-VS increases speed on a temperature increase and decreases speed on a temperature decrease. Reverse acting operation is typically used in cooling applications.



#### Variable Speed Output Response

The 00-VS allows for adjustment to the response rate. The response rate is the speed at which the 00-VS operates to achieve target temperature. The response adjustment is made through DIP switch 4.

The normal response is typically used in applications where the temperature at the sensor being controlled changes gradually during operation.

The fast response is typically used in applications where the temperature at the sensor being controlled changes rapidly during operation.

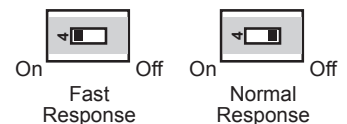



### Output Characteristic

The 00-VS bases its output on a linear characteristic or an equal percentage characteristic. The output characteristic adjustment is made through DIP switch 5.

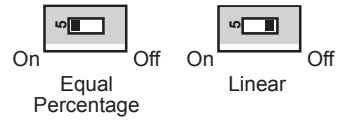

#### Linear Output (DIP switch 5 = Off)

The linear output characteristic assumes there is a linear relationship between percent of full flow of the pump and heat output of the terminal unit. The linear output characteristic is typical of applications in which the pump is injecting into a constant circulating loop which includes the terminal unit.

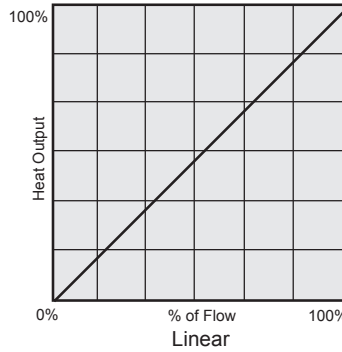

#### Equal Percentage Output (DIP switch 5 = On)

The equal percentage output characteristic assumes there is non-linear relationship between percent of full flow of the pump and heat output of the terminal unit. In order to achieve the desired linear output, the 00-VS provides an equal percentage output. The equal percentage output characteristic is typical of applications in which the pump injects directly into the terminal unit.

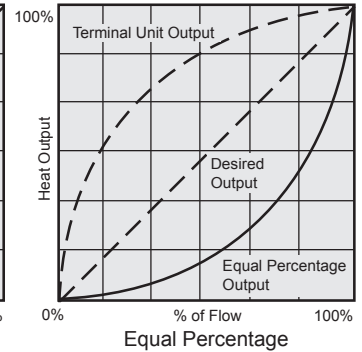

### Setpoint Target (DIP switch 1 = Off)

Once a heat request is present, the 00-VS operates to provide a fixed setpoint target at either the system sensor (S1) or system sensor (S2) location. In this mode, the 00-VS uses the two sensors and DIP switch 2 in order to select different temperature ranges. Select from the four available temperature ranges listed in the table below, the temperature range in which the desired setpoint falls within. Then set the desired setpoint using the RANGE dial, where the first and last temperatures from the selected temperature range corresponds to 1 and 10 respectively on the RANGE dial, with the temperature increasing in 5°F increments.

Note: Only one of the sensors (S1 or S2) can be connected in this mode of operation.

| Sensor installed | Setpoint Range     |                   |
|------------------|--------------------|-------------------|
|                  | DIP switch 2 = Off | DIP switch 2 = On |
| S1               | (A) 30 - 75°F      | (B) 75 - 120°F    |
| S2               | (C) 120 - 165°F    | (D) 165 - 210°F   |

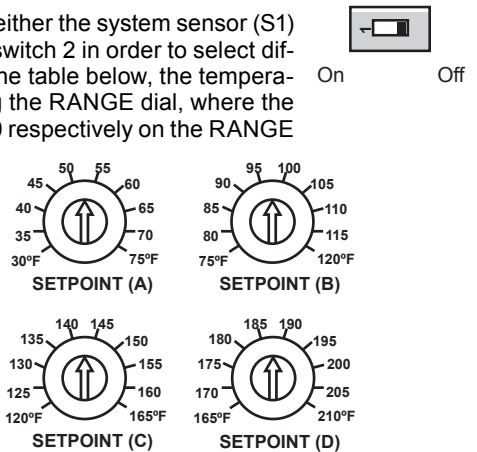

### Boiler Protection

When either system sensor (S1) or system sensor (S2) is installed for setpoint operation, and the boiler return sensor (S3) is installed on the return side of the boiler, the 00-VS can protect the boiler against flue gas condensation. When this sensor is installed, the 00-VS monitors the boiler return temperature. If the boiler return temperature is less than 135°F, the 00-VS turns on the reduced output (RED OUT) LED and decreases the speed of the pump.

Note: Boiler protection is not available when configured for Setpoint Target operation and Reverse Acting mode.

#### Setpoint Operation as a Limit (Boiler Protection with only sensor S3 connected)

Once a heat request is present and only sensor S3 is installed for setpoint operation, the 00-VS operates to provide a limiting setpoint. The 00-VS operates the variable speed output based on the mixing mode of operation. When configured for direct acting, the 00-VS adjusts the variable speed output towards full speed as long as the temperature measured at sensor S3 is above the limiting setpoint. When configured for reverse acting, the 00-VS adjusts the variable speed output towards zero speed as long as the temperature measured at sensor S3 is above the limiting setpoint.

DIP switch 2 is used to select the different temperature ranges. Select from the two available temperature ranges listed in the table below, the temperature range in which the desired setpoint falls within. Then set the desired setpoint using the RANGE dial, where the first and last temperatures from the selected temperature range corresponds to 1 and 10 respectively on the RANGE dial, with the temperature increasing in 5°F increments.

| Sensor installed | Setpoint Range     |                   |
|------------------|--------------------|-------------------|
|                  | DIP switch 2 = Off | DIP switch 2 = On |
| S3               | (B) 75 - 120°F     | (C) 120 - 165°F   |

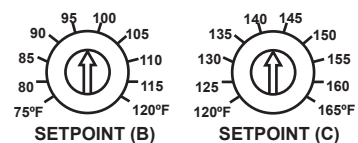

#### ΔT Target (DIP switch 1 = On)

Once a heat request is present, the 00-VS operates to provide a fixed ΔT target between the system sensor (S1) and the system sensor (S2). The S1 sensor is the system return sensor and S2 is the system supply sensor. The fixed ΔT is set using the RANGE dial, where 5°F and 50°F corresponds to 1 and 10 respectively on the RANGE dial, with the temperature increasing in 5°F increments.

Note: The S3 sensor is not functional in this mode of operation.

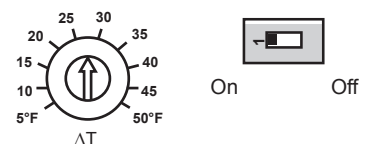

### Minimum Variable Speed Output

When the 00-VS is configured for  $\Delta T$  Target operation and reverse acting mode, a minimum variable speed output is incorporated during operation. In this case the variable speed output is adjusted between the selected minimum variable speed output percentage and full output. Select from the four different minimum variable speed output percentages in the table to the side. The 00-VS also provides full output for 30 seconds when the Heat Request appears, then resumes normal operation. Note: Minimum variable speed output is not available when configured for  $\Delta T$  Target operation and Direct Acting Mode.

| Minimum Variable Speed Output |                    |                   |
|-------------------------------|--------------------|-------------------|
|                               | DIP switch 2 = Off | DIP switch 2 = On |
| DIP switch 5 = On             | 42%                | 62%               |
| DIP switch 5 = Off            | 8%                 | 18%               |

### Exercising

During long periods of no operation, the 00-VS is designed to exercise for 10 seconds every 3 days of no operation in order to prevent precipitate build-up in the pump. The % OUT LED turns on during the exercising function.

### Wiring and Sensor Installation

**WARNING:** Wiring connections must be made in accordance with all applicable electrical codes.

**CAUTION:** To prevent electrical shock, disconnect electric power to system at main fuse or circuit breaker box until installation is complete. When a service switch is installed, more than one disconnect switch may be required to deenergize this device for servicing.

### Powering the control

Insert the line voltage wires through the knockout of the enclosure and connect the live wire to the H terminal and the neutral wire to the N terminal on the PC Board. Ensure that no power is present during this process.

### Heat Request

The heat request signal may be provided by jumpering the heat request (HT Req) terminals or by applying 24 V (ac) to the HT Req terminals. This signal may come from zone valve end switches, Taco ZVC/SR series zone controls, or thermostats. When a thermostat is connected directly to the heat request terminals, use dry contact style. (i.e. mechanical, digital hard wired or digital battery operated)

### Sensors

Do not apply power to these terminals as this will damage the PC Board. The wiring terminals for the sensors may be removed for ease of installation.

Do not run the wires parallel to telephone or power cables. If the sensor wires are located in an area with strong sources of electromagnetic interference (EMI), shielded cable or twisted pair should be used or the wires can be run in a grounded metal conduit. If using shielded cable, the shield wire should be connected to the Com terminal on the PC Board and not to earth ground.

### System and Boiler Return Sensors

The sensors can be strapped directly to the pipe using a cable tie. Insulation should be placed around the sensor to reduce the effect of air currents on the sensor measurement. The sensors should be placed downstream of a pump or after an elbow or similar fitting. This is especially important if large diameter pipes are used because the thermal stratification within the pipe can result in erroneous sensor readings. Proper sensor location requires that the fluid is thoroughly mixed within the pipe before it reaches the sensor. If the system sensor is used to measure duct (air) temperature, the sensor should be mounted in such a manner that it measures the average duct outlet temperature.

### System Sensor (S1)

Connect the two wires from the system sensor (S1) directly into the Com and S2 terminals on the PC Board.

### System Sensor (S2)

Connect the two wires from the system sensor (S2) directly into the Com and S2 terminals on the PC Board.

### Boiler Return Sensor (S3)

Connect the two wires from the boiler return sensor directly into the Com and S3 terminals on the PC Board.

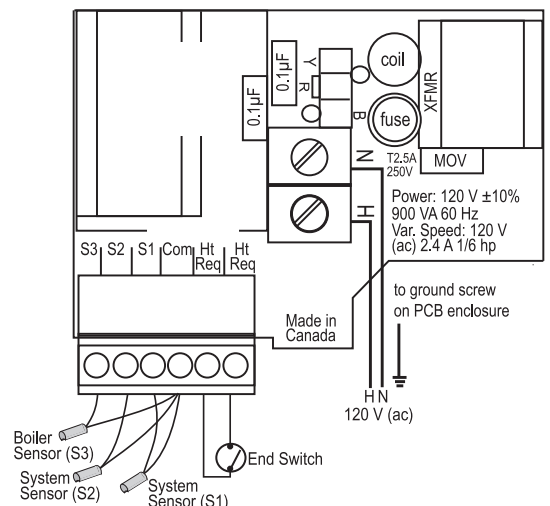



## Troubleshooting

As in any troubleshooting procedure, it is important to isolate a problem as much as possible before proceeding. The error messages greatly simplify troubleshooting of the 00-VS. When the 00-VS flashes an error message, identify the fault and follow standard testing procedures to confirm the problem. If you suspect a wiring fault, return to the wiring section on this brochure and carefully check all external wiring and wiring connections.

For your safety and protection of permanent damage to the microprocessor, the 00-VS includes a 2.5 A 250 V (ac) field replaceable fuse.

## Multi-Status LEDs

| LED                       | LED Status    | 00-VS Status  |
|---------------------------|---------------|---|
| PWR                       | Solid         | Power On  |
| HEAT REQ                  | Solid         | Heat Request  |
| % OUT                     | Flash (Solid) | Variable Speed Output (100% Speed)  |
| RED OUT                   | Solid         | Reduced Output (boiler protection activated)  |
| HEAT REQ                  | Flash         | System Sensor S1 Fault.<br>00-VS does not operate   |
| RED OUT                   | Flash         | System Sensor S2 Fault.<br>00-VS does not operate   |
| HEAT REQ and RED OUT      | Flash         | Boiler Sensor S3 Fault.<br>00-VS does not provide boiler protection.  |
| PWR, HEAT REQ and RED OUT | Flash         | No sensors connected, or incompatible mode and sensor combination.<br>00-VS does not provide boiler protection. |

## Testing The Sensors

A good quality test meter capable of measuring up to 5,000 k $\Omega$  (1 k $\Omega$  = 1000  $\Omega$ ) is required to measure the sensor resistance. In addition to this, the actual temperature must be measured with a good quality digital thermometer.

First measure the temperature using the thermometer and then measure the resistance of the sensor at the 00-VS. The wires from the sensor must not be connected to the PC Board while this test is performed. The wiring terminals are easily removed by pulling them from the PC Board. Using the chart below, estimate the temperature measured by the sensor. The sensor and thermometer readings should be close. If the test meter reads a very high resistance, there may be a broken wire, a poor wiring connection or a defective sensor. If the resistance is very low, the wiring may be shorted, there may be moisture in the sensor or the sensor may be defective. To test for a defective sensor, measure the resistance directly at the sensor location.

| Temperature |     | Resistance | Temperature |    | Resistance | Temperature |    | Resistance | Temperature |    | Resistance |
|-------------|-----|------------|-------------|----|------------|-------------|----|------------|-------------|----|------------|
| °F          | °C  | $\square$  | °F          | °C | $\square$  | °F          | °C | $\square$  | °F          | °C | $\square$  |
| -30         | -34 | 234,196    | 30          | -1 | 34,558     | 90          | 32 | 7,334      | 150         | 66 | 2,045      |
| -20         | -29 | 165,180    | 40          | 4  | 26,099     | 100         | 38 | 5,828      | 160         | 71 | 1,689      |
| -10         | -23 | 118,018    | 50          | 10 | 19,900     | 110         | 43 | 4,665      | 170         | 77 | 1,403      |
| 0           | -18 | 85,362     | 60          | 16 | 15,311     | 120         | 49 | 3,760      | 180         | 82 | 1,172      |
| 10          | -12 | 62,465     | 70          | 21 | 11,883     | 130         | 54 | 3,050      | 190         | 88 | 983        |
| 20          | -7  | 46,218     | 80          | 27 | 9,299      | 140         | 60 | 2,490      | 200         | 93 | 829        |

## Application

1. Maximum operating pressure: 125 psi (862 kPa) on all "00" Series Circulators, 200 psi (1379 kPa) on all Load Match® Circulators.
2. Maximum water temperature not to exceed nameplate rating.
3. Cast iron circulators are to be used for closed loop systems. Bronze circulators are to be used for open loop, fresh water, or potable water systems.
4. Taco Cartridge circulator pumps are for indoor use only – employer uniquement a l'interieur.

**WARNING: Do not use in swimming pool or spa areas; pump has not been investigated for this application.**

**WARNING: In the event the retaining screws have been pulled out of the housing, DO NOT replace them. Use of any other screw may short out the stator windings, creating a risk of electrical shock.**

**CAUTION: When installing electrical connections, do not apply mechanical loads to the capacitor box; otherwise, retaining screws may be pulled out of the housing, making circulator unusable.**

## Installation

1. Mounting position – Circulator must be mounted with the motor in a horizontal position. It may be mounted vertically with the motor up, provided that the system pressure is at least 20 psi (138 kPa).
2. Rotating body – Body has an arrow on the front that indicates direction of flow. To rotate body, remove the four body bolts, rotate body and replace bolts. Make sure that the junction box is NOT located underneath the circulator. (The junction box must NOT be located in the 6 o'clock position, as viewed from the motor end.)
3. Electrical connections – Observe all applicable codes when connecting to power supply. The motor is impedance protected, and does not require overload protection.  
The pump cannot run backwards.
4. Fill system with tap water – The system must be filled before operating the circulator. The bearings are water lubricated and should not be allowed to operate dry. Filling the system will result in immediate lubrication of the bearings. It is always good practice to flush a new system of foreign matter before starting the circulator.
5. Circulator operation – Operate the circulator for 5 minutes immediately after filling system to purge remaining air from the bearing chamber. This is especially important when installing the circulator during the off-season.

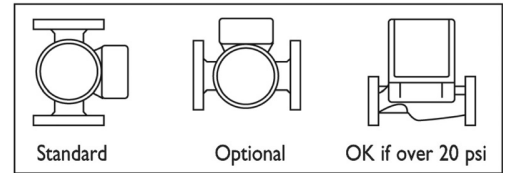

## Replacing Cartridge Assembly

1. Disconnect the electrical supply.
2. Reduce system pressure to 0 psi and allow system to return to room temperature. Isolate the circulator by closing the service valves or draining the system.
3. Remove the body bolts and swing motor assembly away from the body.
4. Pull cartridge out of the motor housing.
5. Install replacement cartridge, making sure that the cover plate is between the cartridge flange and motor.
6. Make sure the replacement cartridge corresponds to the full circulator product number. A complete parts list is available from your local plumbing supply wholesaler.
7. Reassemble the circulator using the new gasket and bolts supplied.
8. Follow the "Installation" procedure to start up the circulator.

## Replacing Integral Flow Check (IFC) Assembly (if applicable)

1. Disconnect the electrical supply.
2. Reduce system pressure to 0 psi and allow system to return to room temperature. Isolate the circulator by closing the service valves or draining the system.
3. Remove the body bolts and swing motor assembly away from the body.
4. Remove IFC, using needle nose pliers.
5. Install replacement IFC by pressing valve into casing until it is firmly seated.
6. Reassemble the circulator using the new gasket and bolts supplied.
7. Follow the "Installation" procedure to start up the circulator.

## Replacing Circuit Board

1. Disconnect the electrical supply and all field wiring to the circuit board.
2. Unplug the 3-pin plastic connector that connects the motor to the circuit board.
3. Bend the lip of the capacitor base to ease the removal of the circuit board. Pull the circuit board up and out.
4. Reverse directions to install the new circuit board.

**CAUTION:** 1. The addition of petroleum based fluids or certain chemical additives to systems utilizing TACO equipment voids the warranty.  
2. Use supply wires suitable for 90°C.

**CAUTION:** Installations at higher elevations over 5000 feet must have higher fill pressure of 20 psi minimum to prevent pump cavitation and flashing. Premature failure may result. Adjust expansion tank pressure to equal fill pressure. A larger size expansion tank may be required.

**ATTENTION:** Employer des fils d'alimentation adéquats pour 90°C.

**WARNING:** To avoid electrical shock, disconnect the power supply to the circulator and the main electrical unit.

## LIMITED WARRANTY STATEMENT

Taco, Inc. will repair or replace without charge (at the company's option) any Taco 00 Series circulator or circulator part which is proven defective under normal use within three (3) years from the date of manufacture.

In order to obtain service under this warranty, it is the responsibility of the purchaser to promptly notify the local Taco stocking distributor or Taco in writing and promptly deliver the subject product or part, delivery prepaid, to the stocking distributor. For assistance on warranty returns, the purchaser may either contact the local Taco stocking distributor or Taco. If the subject product or part contains no defect as covered in this warranty, the purchaser will be billed for parts and labor charges in effect at time of factory examination and repair.

Any Taco product or part not installed or operated in conformity with Taco instructions or which has been subject to misuse, misapplication, the

addition of petroleum-based fluids or certain chemical additives to the systems, or other abuse, will not be covered by this warranty.

If in doubt as to whether a particular substance is suitable for use with a Taco product or part, or for any application restrictions, consult the applicable Taco instruction sheets or contact Taco at (401-942-8000).

Taco reserves the right to provide replacement products and parts which are substantially similar in design and functionally equivalent to the defective product or part. Taco reserves the right to make changes in details of design, construction, or arrangement of materials of its products without notification.

**TACO OFFERS THIS WARRANTY IN LIEU OF ALL OTHER EXPRESS WARRANTIES. ANY WARRANTY IMPLIED BY LAW INCLUDING WARRANTIES OF MERCHANTABILITY OR FITNESS IS IN EFFECT ONLY FOR THE DURA-**

**TION OF THE EXPRESS WARRANTY SET FORTH IN THE FIRST PARAGRAPH ABOVE.**

**THE ABOVE WARRANTIES ARE IN LIEU OF ALL OTHER WARRANTIES, EXPRESS OR STATUTORY, OR ANY OTHER WARRANTY OBLIGATION ON THE PART OF TACO.**

**TACO WILL NOT BE LIABLE FOR ANY SPECIAL, INCIDENTAL, INDIRECT OR CONSEQUENTIAL DAMAGES RESULTING FROM THE USE OF ITS PRODUCTS OR ANY INCIDENTAL COSTS OF REMOVING OR REPLACING DEFECTIVE PRODUCTS.**

This warranty gives the purchaser specific rights, and the purchaser may have other rights which vary from state to state. Some states do not allow limitations on how long an implied warranty lasts or on the exclusion of incidental or consequential damages, so these limitations or exclusions may not apply to you.

**COMFORT MADE EASY®**

**TACO, INC.**, 1160 Cranston Street, Cranston, RI 02920 Telephone: (401) 942-8000 FAX: (401) 942-2360.  
**TACO (Canada), Ltd.**, 8450 Lawson Road, Unit #3, Milton, Ontario L9T 0J8. Telephone: 905/564-9422. FAX: 905/564-9436.

Visit our web site at: <http://www.taco-hvac.com>

Copyright 2010 TACO, Inc.  
Portions Copyright 2003  
tekmar Control Systems Ltd.  
tekmar Control Systems Inc.  
Printed in USA